

Hang szerelő

Ukulele
workshop

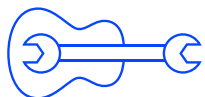

Hang
Szerelő

Ukulele workshop

Nehézségi fok



haladó

Elkészítési idő

kb. 6-8 óra

↓ Anyagszükséglet ↓

- 2 lap 70x100 cm-es sörkarton
- 1 db 3x5 mm-es modellező lécs VAGY hurkapálca
- ukulele húrok: 4 db 25 cm hosszú kalapgumi
VAGY ukulele húrok koncert ukulelére (G, C, E, A)
- hangolókulcsok: 4 db 5 mm - 10 mm szélességű csavar
VAGY hangolókulcs ukuleléhez
- folyékonyragasztó

↓ Eszközsükséglet ↓

- 1 db ragasztópisztoly
- 1 db sniccer
- 3 db vonalzó
(40 cm-es, 15 cm-es, derékszögű)
- 1 db körző
- 10 db csipesz
- 25 db fogpiszkáló
- 1 db kézfűrő olyan fűrőszárral,
ami megegyezik a hangolókulcs
vagy a csavar vastagságával
- 1 db csavarhúzó
- 1 db csípőfogó
- alátét / vágólap

Workshopvezető:
Galavits Matyi

További kérdés esetén írj nekünk a
junior@hellowood.eu email címre.

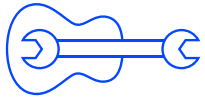

Hang
Szerelő

Ukulele szabásminta

Minden elem méretarányos, ha A/4-es méretben,
0 cm-es margóval nyomtatjátok ki, kivéve azt az
egyet, ahol jelölve van az ellenkezője.

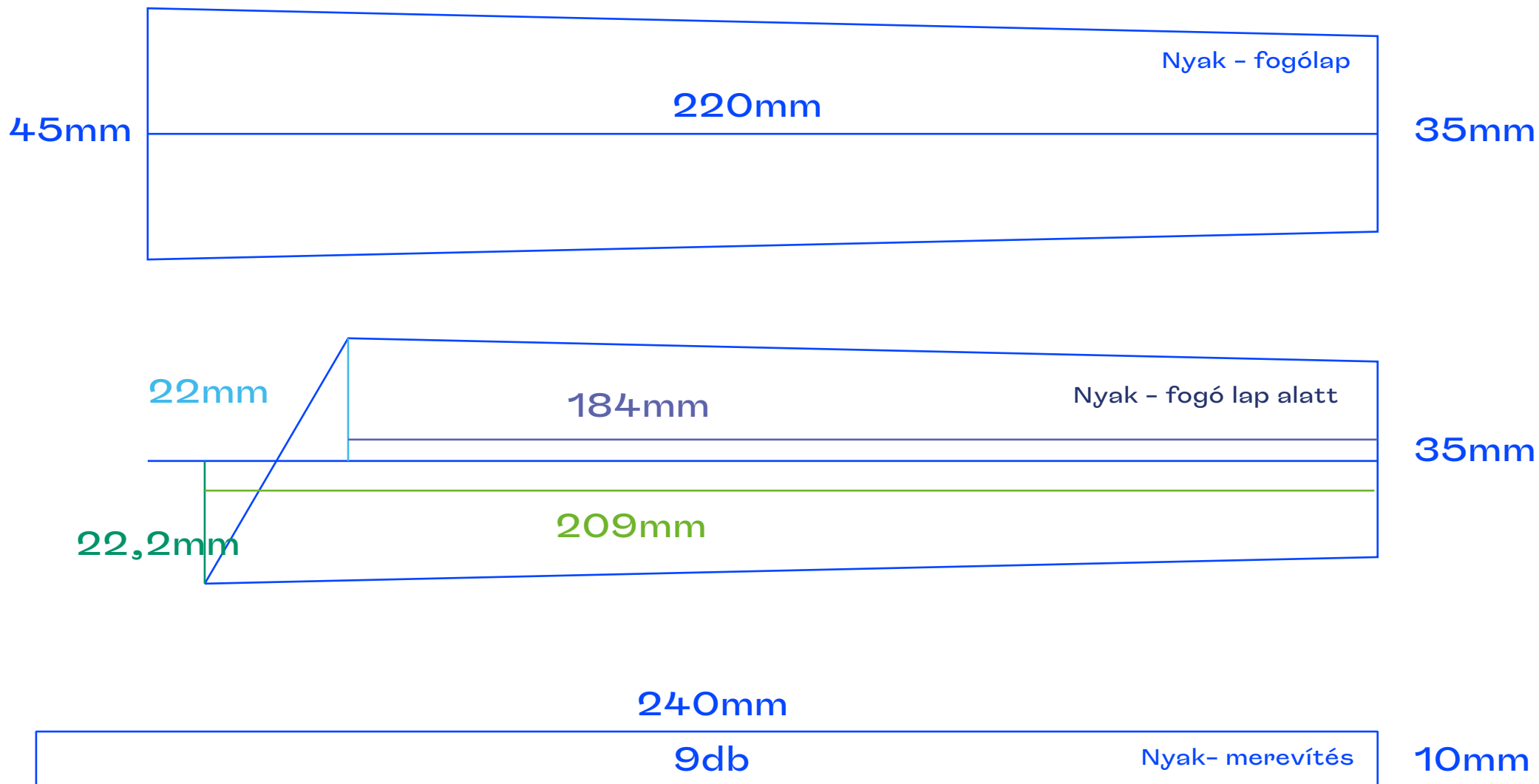

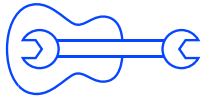

Hang
Szerelő

Ukulele szabásminta



60mm

700mm



10mm

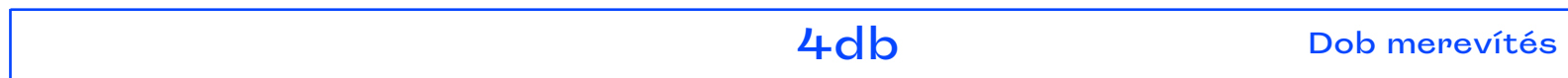

10mm

210mm

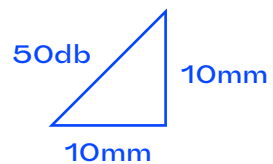

Dob merevítés

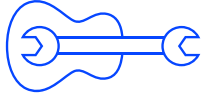

Hang
Szerelő

Ukulele szabásminta

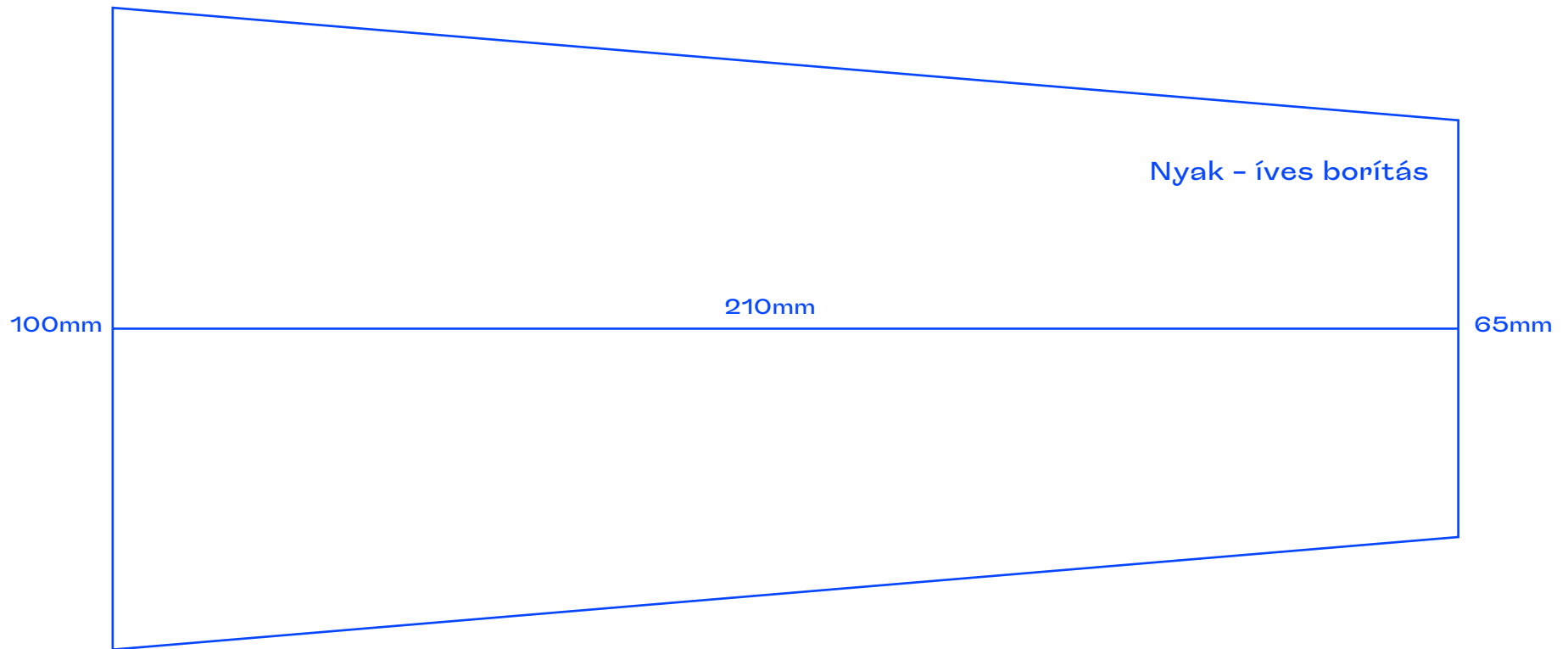
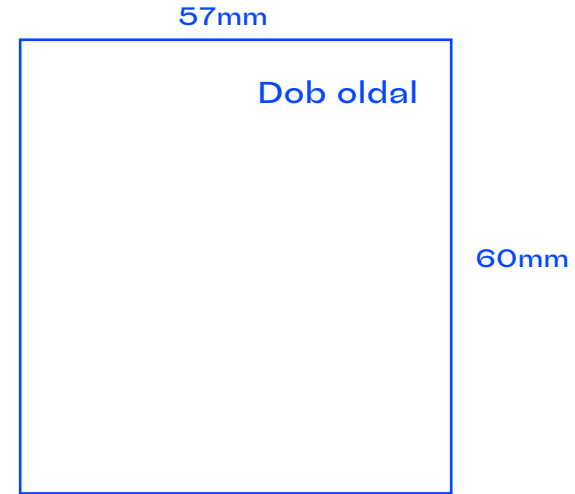

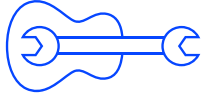

Hang
Szerelő

Ukulele szabásminta

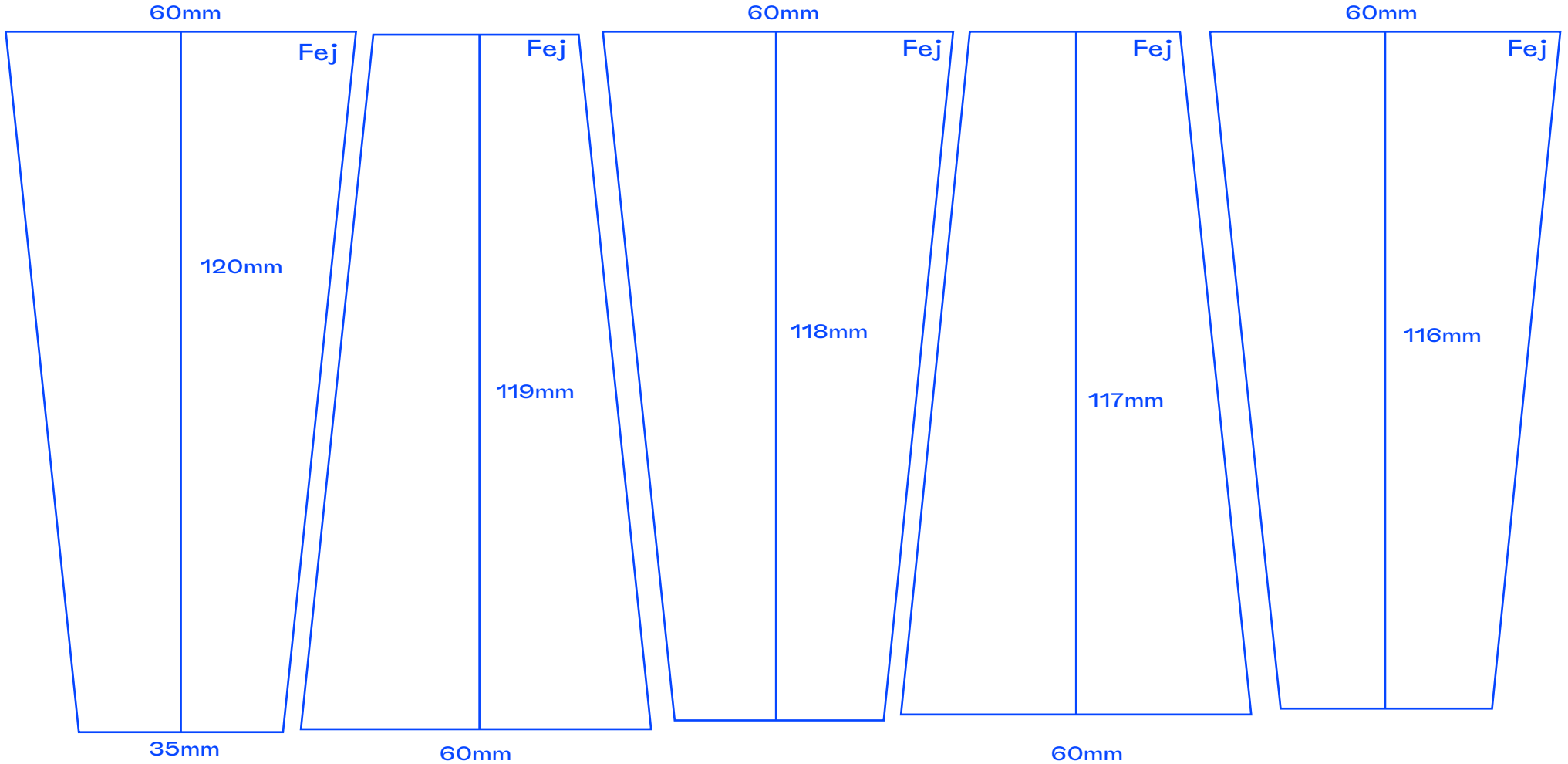
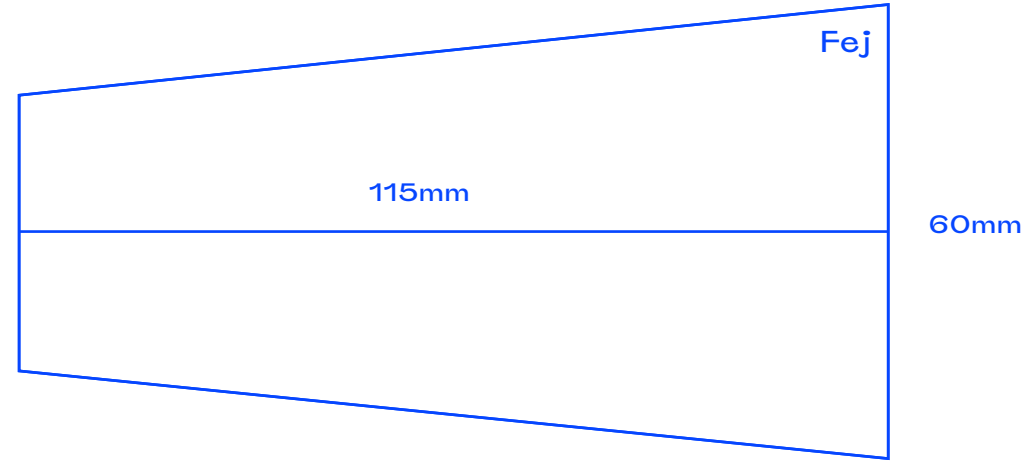

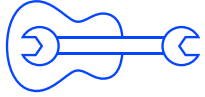

Hang
Szerelő

Ukulele szabásminta

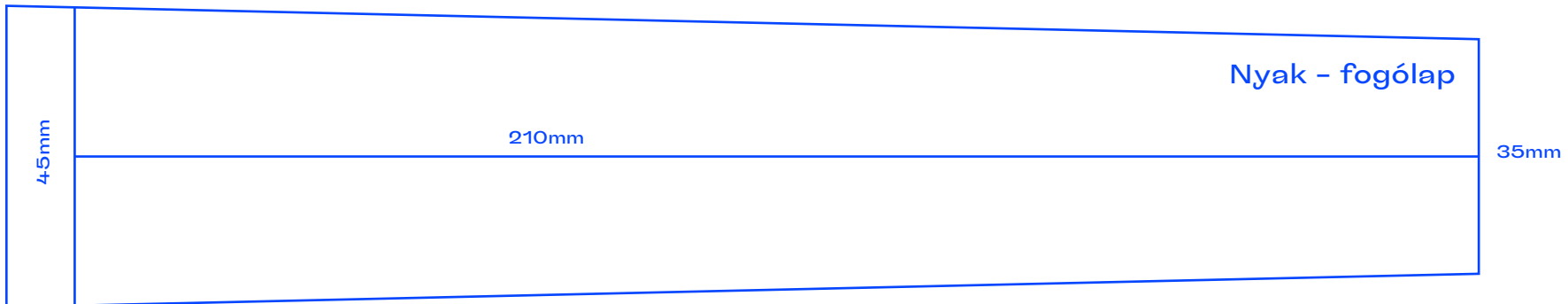
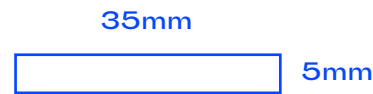
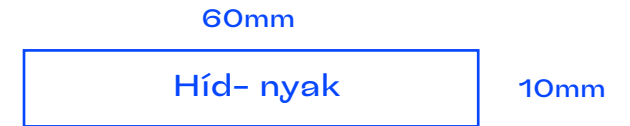
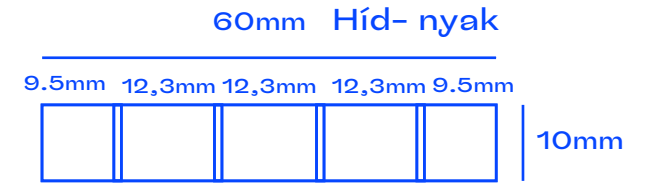

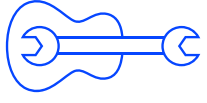

Hang
Szerelő

200 mm

240 mm

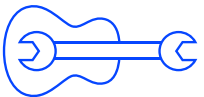

Hang
Szerelő

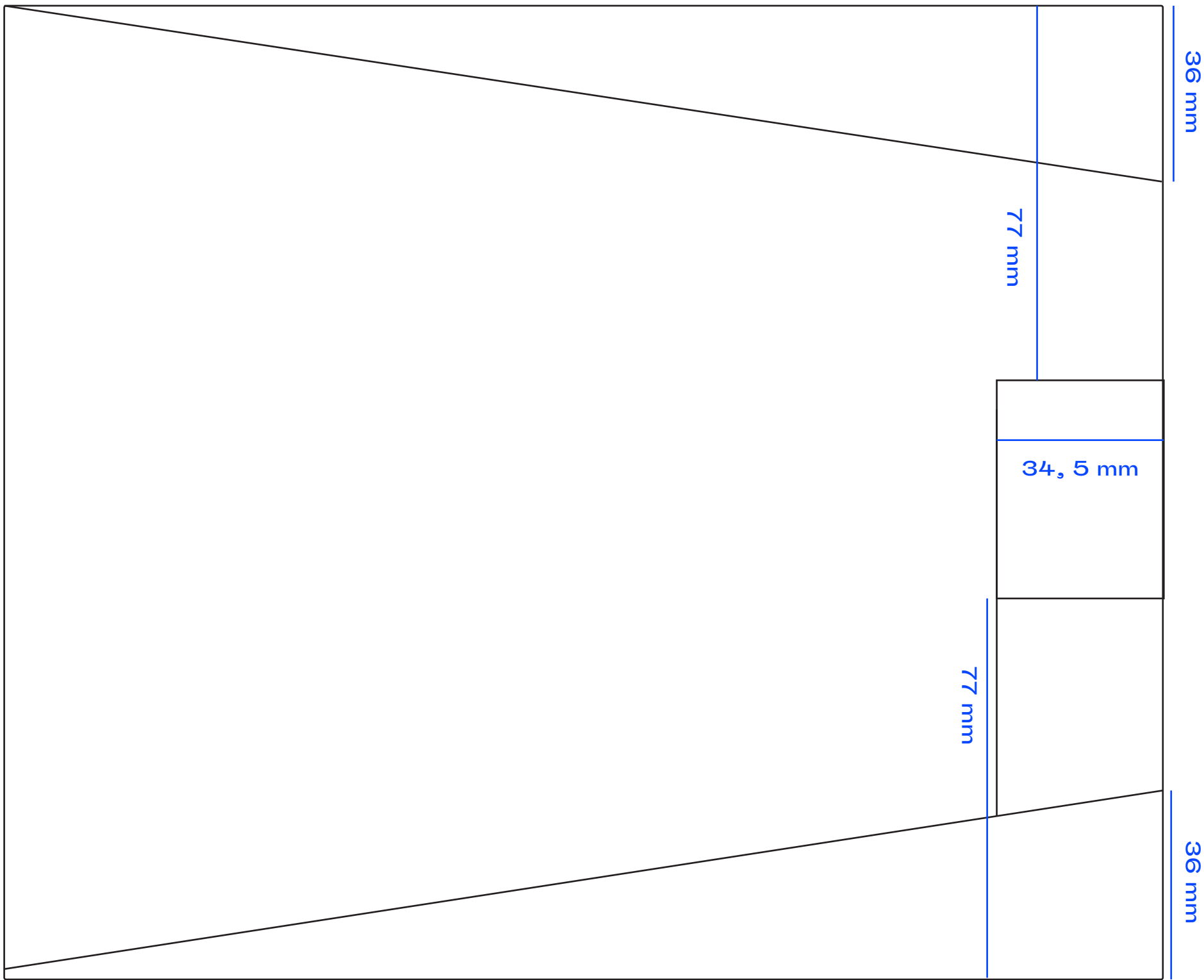

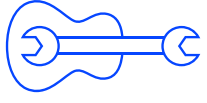

Hang
Szerelő

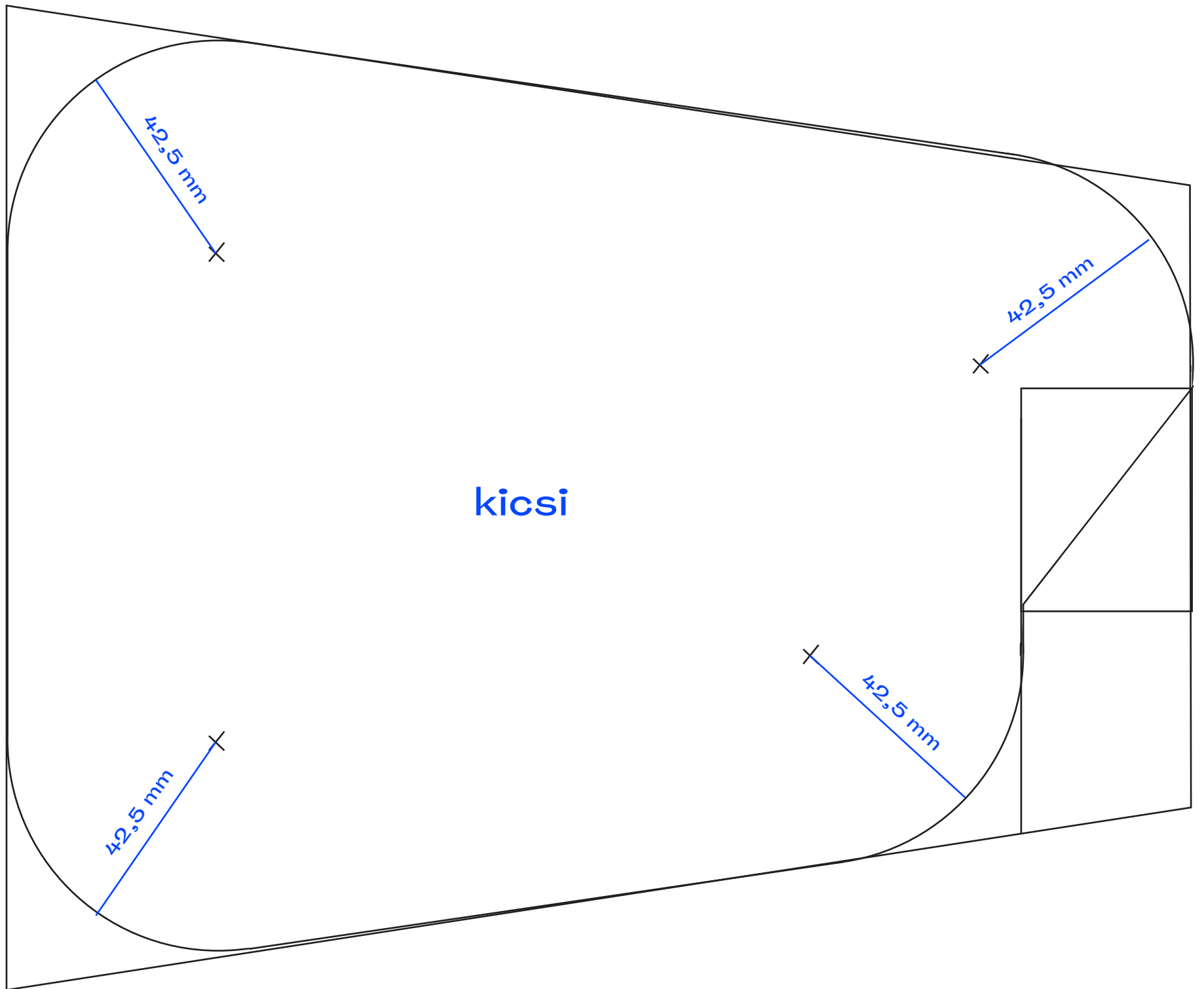

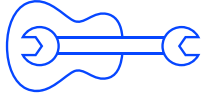

Hang
Szerelő

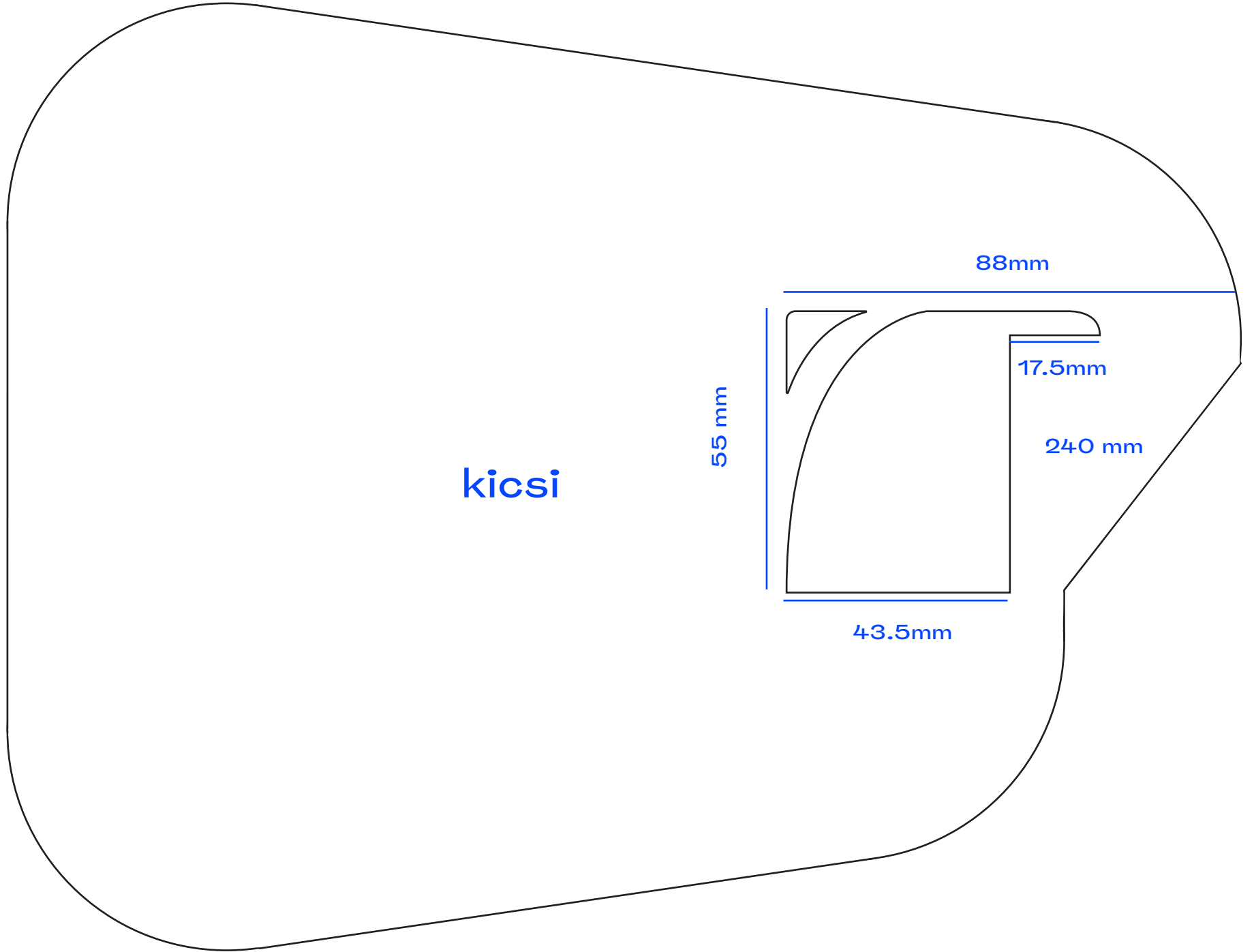

kicsi

88mm

55 mm

17.5mm

240 mm

43.5mm

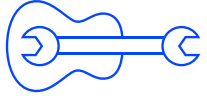

Hang
Szerelő

kicsi

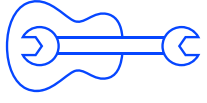

Hang
Szerelő

nagy

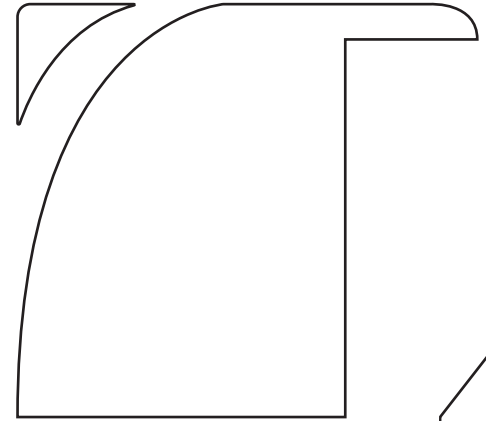

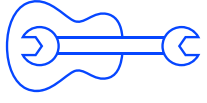

Hang
Szerelő

nagy

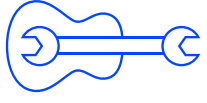

Hang
Szerelő

202 mm

245 mm

nagy

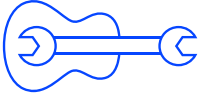

Hang
Szerelő

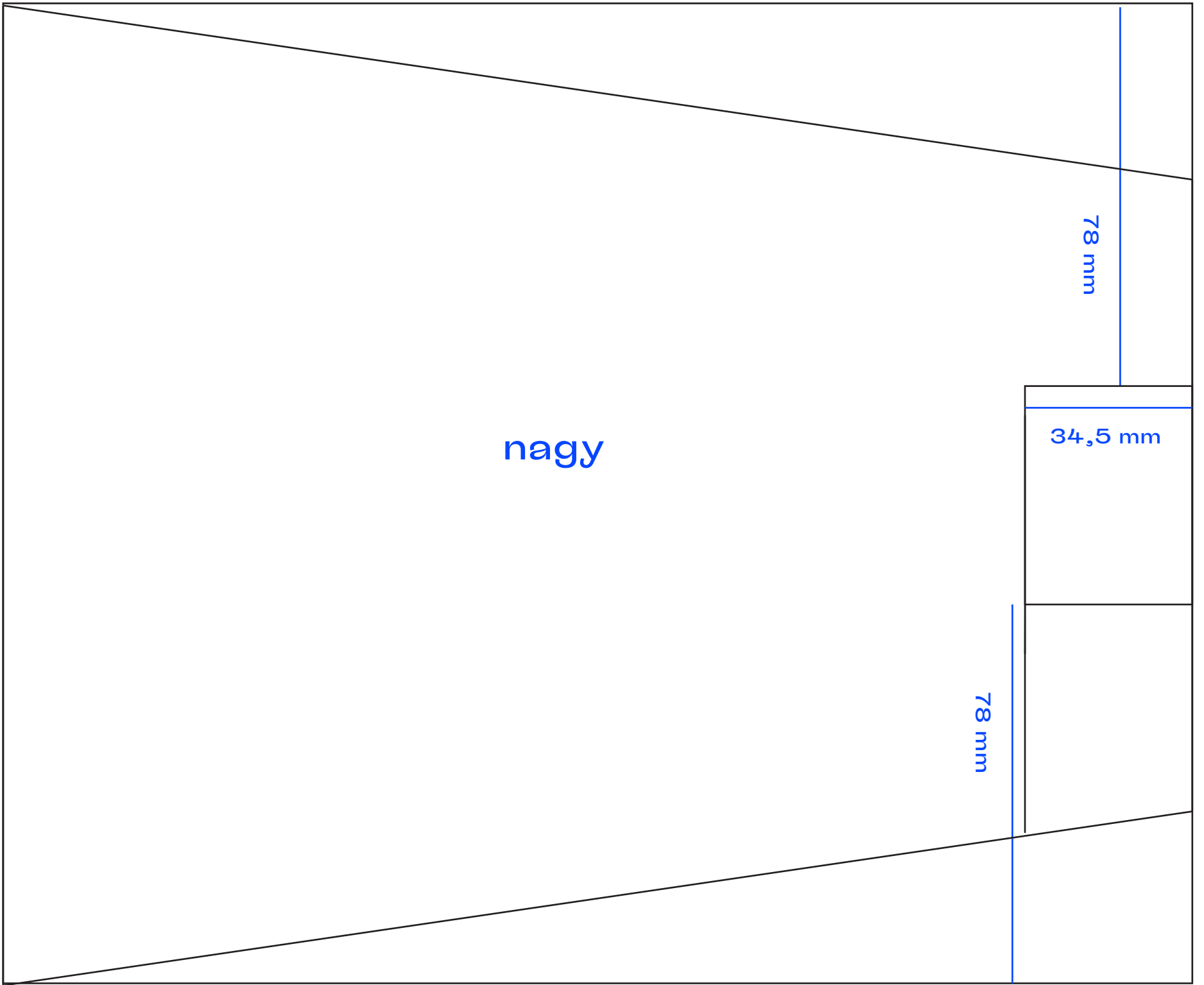

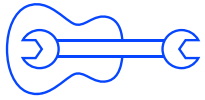

Hang
Szerelő

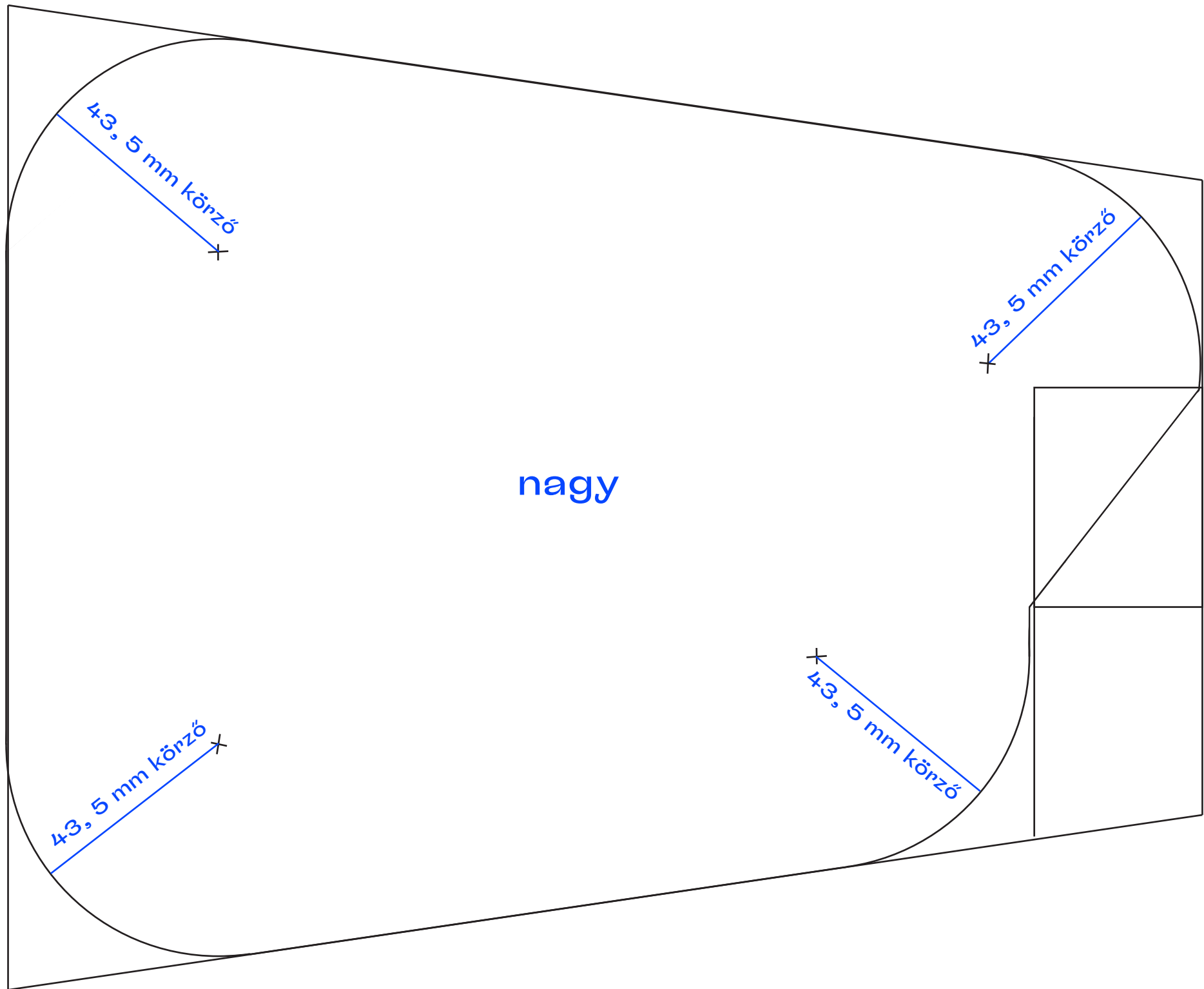

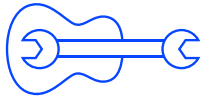

Hang
Szerelő

+

nagy

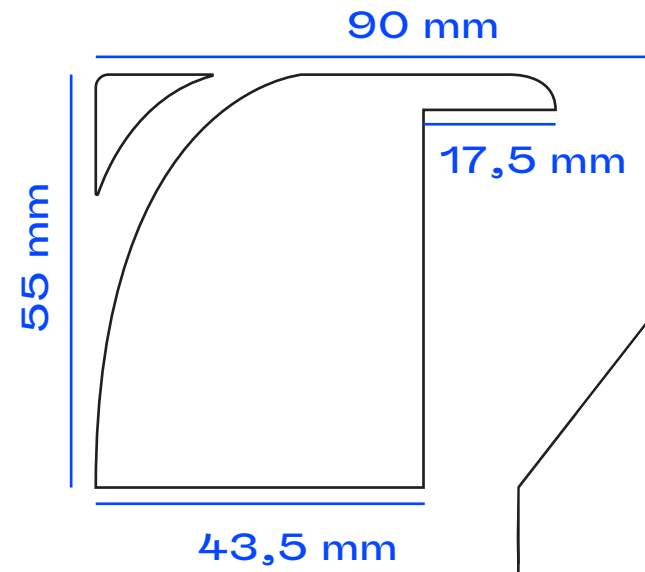



Ukulele mintadarab



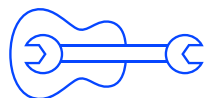

Hang
Szerelő

